

SERIAL NUMBERS
19999 AND BELOW

THE FISHER 90-R



THE FISHER 90-R

SERVICE MANUAL

MODEL 90-R



SERIAL NUMBERS
19999 AND BELOW

PRICE: \$1.00









FISHER RADIO CORPORATION • NEW YORK

N-628-1P

VOLTAGE AND RESISTANCE MEASUREMENTS

Voltage Reference Chart









Set line voltage at 117 volts AC, 50-60 cycles. Readings are in DC volts with respect to chassis ground, unless otherwise noted. Use vacuum-tube voltmeter.

SYMBOL TUBE	CHNL SEL.	TUBE SOCKET PIN NUMBERS								
		1	2	3	4	5	6	7	8	9
V1	AM	0	N	0	7 AC	0	0	0	0	0
	FM	92	N	1.2	7 AC	0	180	90	92	0
V2	AM	0	N	0	0	6.3 AC	0	N	0	0
	FM	120	-1.82	0	0	6.3 AC	135	-1.82	0	0
V3	AM	N	P	6.3 AC	0	220	66	0	X	X
	FM	N	P	6.3 AC	0	190	66	0	X	X
V4	AM	58	N	0	6.3 AC	0	220	N	N	0
	FM	52	N	0	6.3 AC	0	195	N	N	0
V5	AM	N	0	6.3 AC	0	0	0	0	X	X
	FM	N	0	6.3 AC	0	190	85	0	X	X
V6	AM	N	0	6.3 AC	0	0	0	0	X	X
	FM	56	12	6.3 AC	0	190	100	12	X	X
V7	AM	N	P	0	6.3 AC	210	80	0	X	X
	FM	0	0	0	6.3 AC	0	0	0	X	X
V8	AM	-9	0	6.3 AC	0	225	98	N	X	X
	FM	0	0	6.3 AC	0	0	0	N	X	X
V9	AM	N	0	6.3 AC	0	N	N	N	X	X
	FM	N	0	6.3 AC	0	N	N	96	X	X
V10	AM	N	X	0	0	6.3 AC	190	45	X	45
	FM	-1.5	X	0	0	6.3 AC	170	50	X	50
V11	AM	110	0	1.6	3.3 ACc	3 ACc	70	0	1.6	0
	FM	100	0	1.6	3.3 ACc	3 ACc	60	0	1.6	0
V12	AM	210 AC	X	235	0	6.3 AC	X	210 AC	X	X
	FM	210 AC	X	245	0	6.3 AC	X	210 AC	X	X
Electrolytic Capacitor	CHNL SEL.	TERMINAL SYMBOL	VOLTAGE	NOTES						
C87-A	AM		235	AC AC volts	N Less than 1 volt DC, negative P Less than 1 volt DC, positive X No connection a Varies from -1.5 to -3V with position of dial pointer b Varies from 6V to 18V with setting of R47, muting adjustment c Varies from zero to 6.3V AC, with setting of R84, hum adjustment					
	FM		245							
C87-B	AM		220							
	FM		240							
C87-C	AM		195							
	FM		220							
C87-D	AM		165							
	FM		185							

All readings taken with vacuum-tube voltohmmeter with respect to chassis ground, subject to 10% normal variation unless otherwise noted. Set dial pointer at extreme low end of scale. Volume control maximum, clockwise. Tone controls flat. Loudness contour and presence controls off. Rumble filter at 20 cycles, noise filter at 20 KC. DISTANT pushbutton depressed. Refer to parts list for key to geometrical symbols used on electrolytic capacitors.

Resistance Reference Chart

Disconnect the chassis AC power cord. Discharge all electrolytic capacitors to chassis ground through 100-ohm resistor. Disconnect all cables to associated equipment. Readings are in ohms unless otherwise noted.

SYMBOL TUBE	CHNL SEL.	TUBE SOCKET PIN NUMBERS								
		1	2	3	4	5	6	7	8	9
V1	AM	INF.	1M	100	L	0	40K	180K	INF.	0
	FM	INF	1M	100	L	0	30K	180K	INF	0
V2	AM	45K	1.5K	0	0	L	50K	820K	0	0
	FM	35K	1.5K	0	0	L	50K	820K	0	0
V3	AM	1.5M	100	L	0	150K	130K	0	X	X
	FM	1.5M	100	L	0	30K	170K	0	X	X
V4	AM	220K	2.4M	0	L	0	150K	700K	70K	0
	FM	120K	2.4M	0	L	0	35K	700K	70K	0
V5	AM	150K	0	L	0	100K	40K	0	X	X
	FM	150K	0	L	0	100K	30K	0	X	X
V6	AM	470K	2.2K	L	0	40K	20K	2.2K	X	X
	FM	470K	2.2K	L	0	30K	20K	2.2K	X	X
V7	AM	800K	100	0	L	140K	190K	0	X	X
	FM	800K	100	0	L	350K	400K	0	X	X
V8	AM	22K	L	L	0	150K	170K	2.2M	X	X
	FM	22K	L	L	0	400K	400K	2.2M	X	X
V9	AM	470Ka,b	0	L	0	450K	1.5M	570K	X	X
	FM	470Ka,b	0	L	0	450K	1.5M	570K	X	X
V10	AM	290K	X	0	0	L	190K	660K	X	660K
	FM	3.4M	X	0	0	L	54K	500K	X	500K
V11	AM	340K	0	560	50	50	137K	0	560	1M
	FM	204K	0	560	50c	50c	100K	0	560	1M
V12	AM	80	X	160K	0	L	X	80	X	X
	FM	80	X	40K	0	L	X	80	X	X
Electrolytic Capacitor	CHNL SEL.	TERMINAL SYMBOL	RESISTANCE	NOTES						
C87-A	AM		160K	K Kilohms	L Less than 1 ohm M Megohms X No connection a Disconnect one lead of CR4, if necessary, to obtain correct reading. b Varies (with CR4 in circuit) with setting of R47, muting adjustment c Varies from zero to 100 ohms with setting of R84, hum adjustment					
	FM		40K							
C87-B	AM		160K							
	FM		40K							
C87-C	AM		160K							
	FM		40K							
C87-D	AM		190K							
	FM		54K							

PARTS DESCRIPTION LIST

CAPACITORS
20% tolerance for all fixed capacitors, unless otherwise noted or marked GMV (guaranteed minimum value.) Cer = Ceramic.

Symbol	Order No.	Description
C1	C-628-118	Variable, FM-AM tuning
C2	Part of C1	Trimmer, FM RF
C3	CC20CH050P5	Ceramic, 5 uuf NPO, 500V
C4, 5	C-50070-5	Ceramic, 100 uuf GMV, N1500, 1000V
C6	C-50071-2	Cer, .001 uf GMV, 1000V
C7-10	C-629-172	Ceramic, feed-through, .001 uf GMV, 600V
C11	C-50071-4	Ceramic, .005 uf GMV, 500V
C12	C-50071-2	Ceramic, .001 uf GMV, 1000V
C13	CC21GP680K5	Ceramic, 68 uuf, 10% 500V
C14	C-643-153	Trimmer, FM mixer
C520-159	Early units	Ceramic, 3uuf NPO, 500V
C15	CC20CH030D5	Early units; Cer, 5 uuf NPO, 500V
C16	CC20CH050F5	Ceramic, 5 uuf NPO, 500V
C17	CC21GP240K5	Ceramic, 24 uuf, 10%, 500V
C18	CC21GP121K5	Ceramic, 120 uuf, 10%, 500V
C19	C-643-153	Trimmer, FM Oscillator
C520-159	Eady units	Ceramic, 15 uuf N470, 500V
C20	CC20SJ180J5	Early units; Cer, 18 uuf N330, 5%, 500V
C21, 22	C-577-121	Cer, 100 uuf, 600V
C23	CC21GP102K5	Ceramic, .001 uf, 10%, 500V
C24	C-629-172	Cer, feed-through, .001 uf GMV, 600V
C25, 26	C-50071-4	Ceramic, .005 uf GMV, 500V
C27, 28	C-3334	Mica, 470 uuf, 5%, 300V
C29	C-50071-3	Ceramic, .02 uf, +80/-20%, 600V
C30	CC20CH100G5	Ceramic, 10 uuf NPO, 500V
C31, 32	C-50071-4	Ceramic, .005 uf GMV, 500V
C33	C-50070-1	Ceramic, 1 uuf P100, 1000V
C34	CC21GP221K5	Ceramic, 220 uuf, 10%, 500V
C35, 36	C-50071-4	Ceramic, .005 uf GMV, 500V
C37	C-50070-5	Cer, 100 uuf GMV, N1500, 1000V
C38	C-629-175	Electrolytic, 4 uf, 50V
C39	CC20CH050F5	Ceramic, 5 uuf NPO, 500V
C40	C-50070-5	Cer, 100 uuf GMV, N1500, 1000V
C41	CC20CH050F5	Ceramic, 5 uuf NPO, 500V
C42	C-50071-4	Ceramic, .005 uf GMV, 500V
C43	C-50071-2	Ceramic, .001 uf GMV, 1000V

C44, 45	C-50071-4	Ceramic, .005 uf GMV, 500V
C46, 47	C-50072-1	Ceramic, 330 uuf GMV, 1000V
C48	C-629-138	Electrolytic, 8 uf, 50V
C49	C-50072-1	Ceramic, 330 uuf GMV, 1000V
C50	C-50071-2	Ceramic, .001 uf GMV, 1000V
C51	C-50072-3	Ceramic, .001 uuf, 10%, 1000V
C52	CC21GP240K5	Ceramic, 24 uuf, 10%, 500V
C53	CC21GP121K5	Ceramic, 120 uuf, 10%, 500V
C54	Part of C1	Trimmer, AM RF
C55, 56	C-50071-3	Ceramic, .02 uf, +80/-20%, 600V
C57	C-50070-4	Cer, 47 uuf N750, 10%, 1000V
C58	C-50071-4	Ceramic, .005 uf GMV, 500V
C59	C-50077-6N	Special, 0.68 uuf, 500V
C60	CC20CH100G5	Ceramic, 10 uuf NPO, 500V
C61	Part of C1	Trimmer, AM RF
C62	C-50070-5	Cer, 100 uuf GMV, N1500, 1000V
C63	CC21GP121K5	Ceramic, 120 uuf, 10%, 500V
C64	CC20VK100G5	Ceramic, 10 uuf N1400, 500V
C65	Part of C1	Trimmer, AM oscillator
C66	C-50071-3	Ceramic, .02 uf, +80/-20%, 600V
C67	C-3334	Mica, 470 uuf, 5%, 300V
C68	C-50071-4	Ceramic, .005 uf GMV, 500V
C69	C-3334	Mica, 470 uuf, 5%, 300V
C70	C-50074-27	Molded, .047 uf, 10%, 250V
C71	C-50070-3	Cer, 30 uuf N150, 10%, 1000V
C72	C-629-151-1	Trimmer, AM 10-KC filter
C73	CC21GP470K5	Ceramic, 47 uuf, 10%, 500V
C74	C-50071-3	Ceramic, .02 uf, +80/-20%, 600V
C75, 76	C50071-2	Ceramic, .001 uf GMV, 1000V
C77	C-50071-4	Ceramic, .005 uf GMV, 500V
C78	C-50071-2	Ceramic, .001 uf GMV, 1000V
C79	C-50071-4	Ceramic, .005 uf GMV, 500V
C80	C-629-151-2	Trimmer, AM loopstick
C81	C-546-126	Electrolytic, 0.1 uf, 250V
C82	C-50074-28	Molded, 0.1 uf, 10%, 250V
C83	C-639-114	Electrolytic, 25 uf, 6V
C84	C-50071-3	Ceramic, .02 uf, +80/-20%, 600V
C85	CC20SJ180J5	Ceramic, 18 uuf, 5%, N330, 500V
C86	C-50071-3	Ceramic, .02 uf, +80/-20%, 600V

RESISTORS AND POTENTIOMETERS

In ohms, 10% tolerance, 1/2 watt, unless otherwise noted. K = Kilohm, M = Megohm.

Symbol	Order No.	Description
R1	RC20BF221K	Composition, 220
R2	RC20BF474K	Composition, 470K
R3	RC20BF101K	Composition, 100
R4, 5	RC20BF334K	Composition, 330K
R6	RC20BF102K	Composition, 1K
R7	RC20BF824K	Composition, 820K
R8	RC20BF474K	Composition, 470
R9	RC20BF152K	Composition, 1500
R10	RC30BF682K	Composition, 6800, 1W
R11	RC30BF103K	Composition, 10K, 1W
R12	RC20BF101K	Composition, 100
R13, 14	RC20BF823K	Composition, 82K
R15	RC20BF102K	Composition, 1K
R16	RC20BF101K	Composition, 100
R17	RC20BF100K	Composition, 100
R18	RC20BF824K	Composition, 820K
R19, 20	RC20BF225K	Composition, 2.2M
R21, 22	RC20BF823K	Composition, 82K
R23	RC20BF102K	Composition, 1K
R24	RC20BF563K	Composition, 56K
R25	RC20BF223K	Composition, 22K
R26	RC20BF335K	Composition, 3.3M
R27	RC20BF101K	Composition, 100
R28	RC20BF226K	Composition, 22M
R29	RC20BF563K	Composition, 56K
R30	RC20BF224K	Composition, 220K
R31	RC20BF223K	Composition, 22K
R32	RC20BF474K	Composition, 470K
R33	RC20BF102K	Composition, 1K
R34, 35	RC20BF474K	Composition, 470K
R36	RC20BF272K	Composition, 270K
R37	RC20BF183K	Composition, 18K
R38	RC30BF183K	Composition, 18K, 1W
R39	RC20BF152K	Composition, 1500
R40	RC20BF271K	Composition, 270
R41	RC20BF152K	Composition, 1500
R42, 43	RC20BF683K	Composition, 68K
R44	RC20BF102K	Composition, 1K
R45	RC20BF583K	Composition, 68K
R46	RC20BF103K	Composition, 10K
R47	R-629-141-1	Potentiometer, 50K, 20% FM muting adjust
R48	RC20BF224K	Composition, 220K
R49	RC20BF123K	Composition, 12K
R50	RC20BF183K	Composition, 18K
R51	RC20BF102K	Composition, 1K
R52	RC20BF474K	Composition, 470
R53	RC20BF105K	Composition, 1M
R54	RC20BF225K	Composition, 2.2M
R55	RC20BF101K	Composition, 100

R56	RC20BF473K	Composition, 47K
R57	RC20BF222K	Composition, 220K
R58	RC20BF474K	Composition, 47
R59	RC20BF824K	Composition, 820K
R60	RC20BF223K	Composition, 22K
R61	RC30BF223K	Composition, 22K, 1W
R62	RC20BF102K	Composition, 1K
R63	RC20BF101K	Composition, 100
R64	RC20BF226K	Composition, 22M
R65	RC20BF104K	Composition, 100K
R66	RC20BF334K	Composition, 330K
R67	RC20BF683K	Composition, 68K
R68	R-629-141-2	Potentiometer, 200K, 20%, AM 10-KC filter adjust
R69	RC20BF101K	Composition, 100
R70	RC20BF104K	Composition, 100K
R71	RC20BF474K	Composition, 470K
R72	RC20BF156K	Composition, 15M
R73	RC20BF104K	Composition, 100K
R74	RC20BF154K	Composition, 150K
R75	RC20BF473K	Composition, 47K
R76	RC20BF561K	Composition, 560
R77	RC20BF225K	Composition, 2.2M
R78	RC20BF105K	Composition, 1M
R79	RC20BF334K	Composition, 330K
R80	R-520-139	Potentiometer, 500K, 20% output level
R81	RC20BF103K	Composition, 10K
R82	RC40BF391K	Composition, 390, 2W
R83	RC40BF271K	Composition, 270, 2W
R84	R-516-128	Potentiometer, 500, 20%, hum adjust

COILS, TRANSFORMERS, CHOKES

Symbol	Order No.	Description
L1	L-50066-8	Choke, antenna, 3.3 uh
L2	L-629-177	Coil, tuned, FM antenna
L3	L-50066-3	Choke, RF, 1.2 uh
L4	L-50066-19	Choke, RF, 0.56 uh
L5	L-629-180	Choke, assembly, FM RF
L6	L-50066-19	Choke, RF, 0.56 uh
L7	L-629-178	Coil, tuned, FM RF
L8	L-50066-3	Choke, RF, 1.2 uh
L9	L-629-179	Coil, tuned, FM oscillator
L10	L-50066-3	Choke, RF, 1.2 uh
L11	L-551-121	Coil assy, tuned FM lim.
L12	L-629-176	Loopstick, AM antenna
L13	L-629-171	Coil, tuned, AM antenna
L14	L-556-125	Coil, tuned AM RF
L15	L-50066-3	Choke, RF, 1.2 uh
L16	C-550-122	Coil, tuned, AM oscillator
L17	L-50066-3	Choke, RF, 1.2 uh
L18	L-629-152	Coil, AM 10-KC filter
L19	L-50066-19	Choke, filament, 0.56 uh
L20-23	L-592-189	Choke, ferrite bead, filament
L24	L-520-156	Choke, filament
L25	L-50066-19	Choke, filament, 0.56 uh
L26, 27	L-50066-3	Choke, RF, 1.2 uh
T1	T-628-121	Transformer, power
Z1	ZZ-630-114	Transf. assy, 1st FM IF
Z2, 3	ZZ-629-142	Transformer assy, 2nd and 3rd FM IF

Z4	ZZ-592-170	Transf. assy, FM det
Z5, 6	ZZ-629-135	Transf. assy, 1st and 2nd AM IF
Z7	ZZ-2984	Transf. assy, 3rd AM IF

MISCELLANEOUS

Symbol	Order No.	Description
CR1, 2	V-1N295	Crystal diode, FM limiter
CR3, 4	V-1N541	Crystal diode, FM muting (Some units) Inter-changeable with V-1N541
V-1N66	V-1N66	Crystal diodes, matched pair, FM detector
CR5, 6	V-1N542	Fuse, 1 ampere Lamp, channel indicator
F1	F-3329	Lamp, dial edge lighting
I1-6	I-588-120	Jack, output
I7, 8	I-563-145	Jack, input
J1	J-3143	Jack, output
J2, 3	J-3143	Jack, input
J4	J-546-129	Receptacle, auxiliary AC
J5-7	J-3143	Jack, input
J8, 9	J-546-129	Receptacle, auxiliary AC
L*	AS-520-163-2	Dipole antenna, FM Plug, input, RETMA type
P*	P-1031	Channel selector, for chassis serial numbers ending in "B"
S1	S-628-124	Channel selector, for chassis serial numbers ending in "B"
S2	S-628-117	Channel selector, for chassis serial numbers ending in "A"
S2	S-628-117	Switch, pushbutton, muting and bandwidth
S3	S-629-156	Switch, AM antenna
S4	S-628-122	Switch, AC power
SR1	SR-629-157	Selenium rectifier, fil

MECHANICAL PARTS

ORDER NO.	DESCRIPTION
A-629-154	Dial pointer
N-629-133	Dial glass
AS-520-154	Dial glass corner bracket assy
AS-628-119	Escutcheon (with side windows)
AS-628-112	Dress panel (with-out escutcheon)
AS-628-129	Dress panel and escutcheon, assembled
E-50049-3	Knob, channel selector, for chassis serial numbers ending in "B"
E-50049-12	Knob, channel selector, for chassis serial numbers ending in "A"
E-50049-3	Knob, station selector, for chassis serial numbers ending in "B"
E-50049-1	Knob, station selector, for chassis serial numbers ending in "A"

MOUNTING HARDWARE

H121S472AA	Machine screw, four required, 1 inch/10-32/RH
H103W142	Flat washer, four required

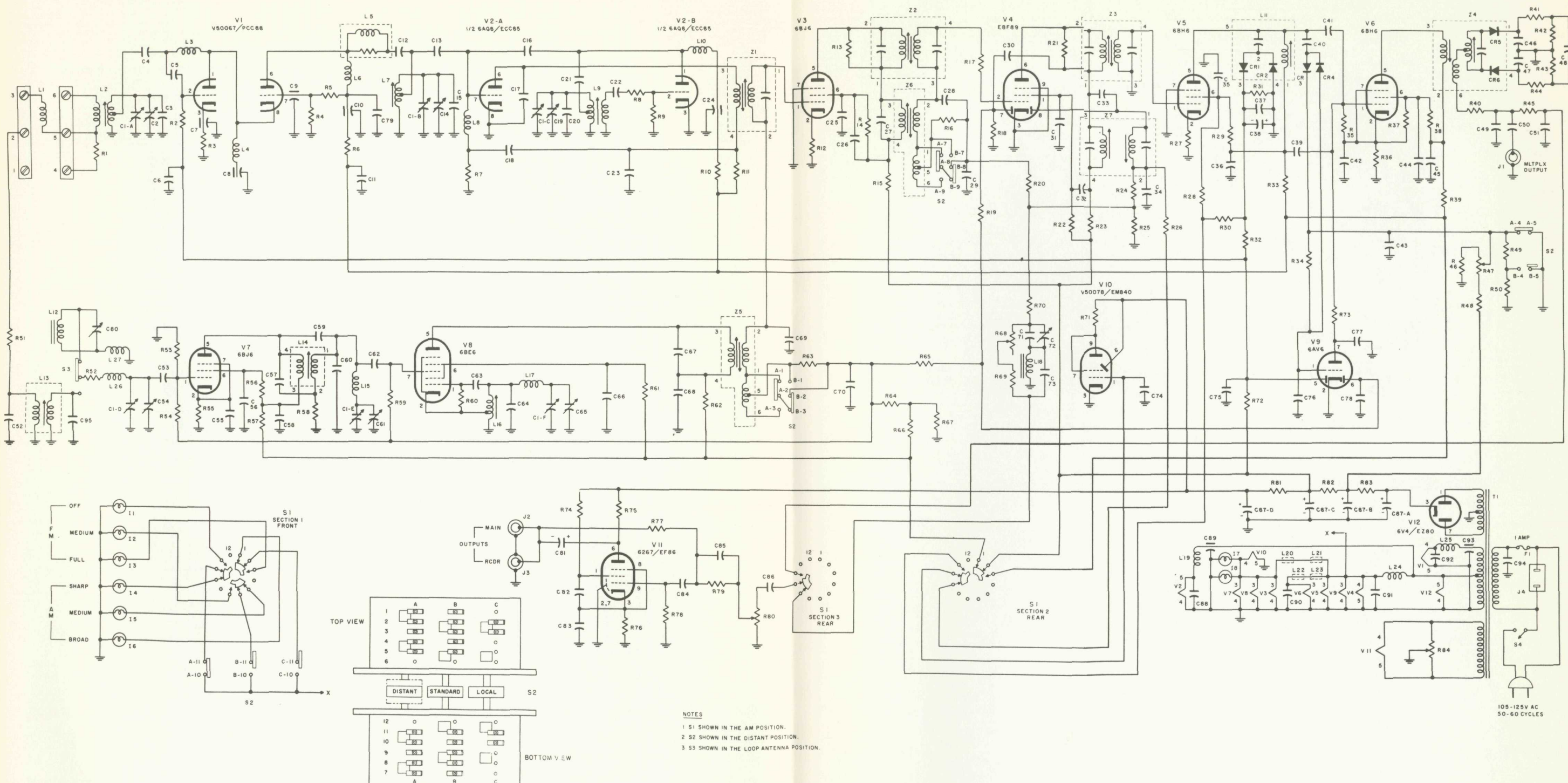

NOTES
 1 S1 SHOWN IN THE AM POSITION.
 2 S2 SHOWN IN THE DISTANT POSITION.
 3 S3 SHOWN IN THE LOOP ANTENNA POSITION.

SCHEMATIC DIAGRAM

THE FISHER 90-R

CIRCUIT CHANGE: This modification is designed to improve rejection of ignition interference. Remove resistor R21. Instead of grounding pin 3 of Z3, insert a 150-K composition resistor and a 47-uuf ceramic capacitor in parallel to ground. Remove R27. Wire pin 2 (cathode) of V5 directly to ground. Tune to FM station and peak Z3, primary and secondary, for maximum closure on tuning indicator, using K-tran tool. Parts required: one 150-K composition resistor, 10%, 1/2 watt, and one 47-uuf ceramic capacitor, 10%.

CHASSIS, TOP VIEW

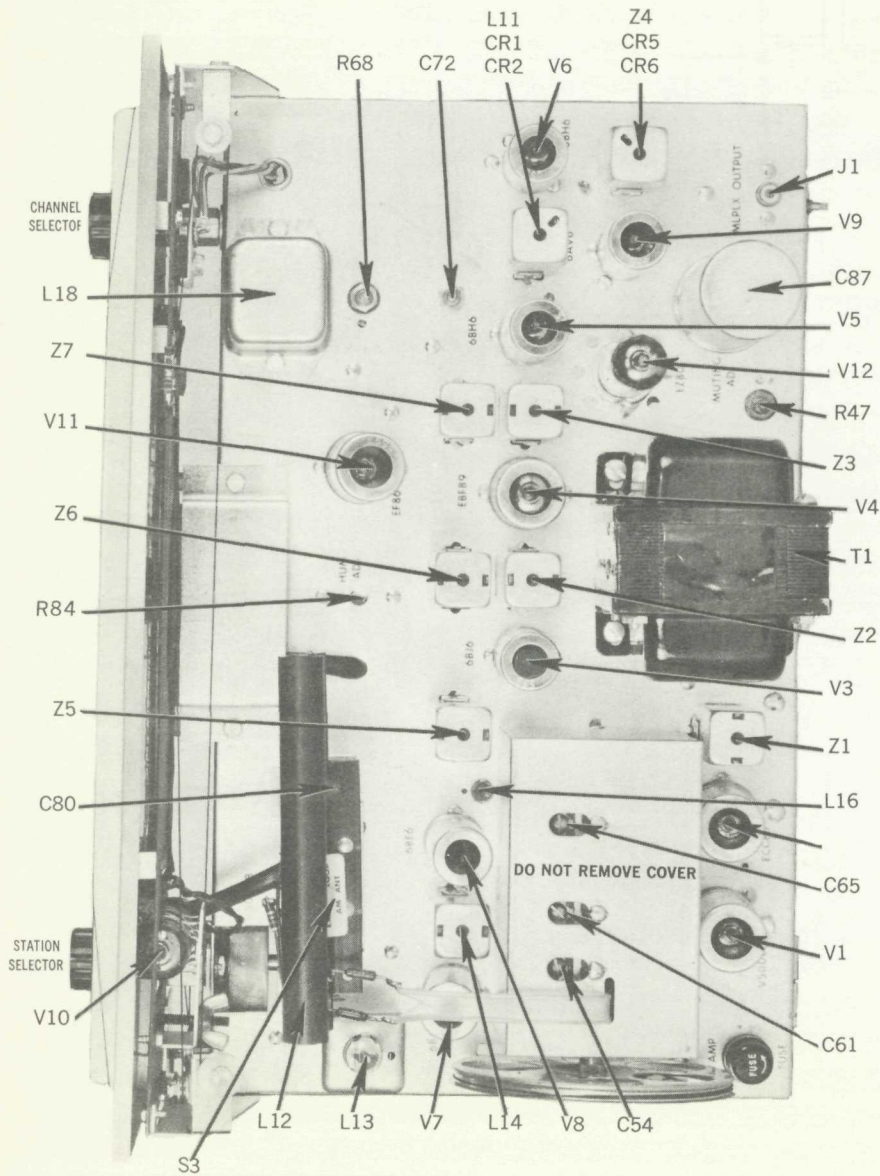

CHASSIS, BOTTOM VIEW

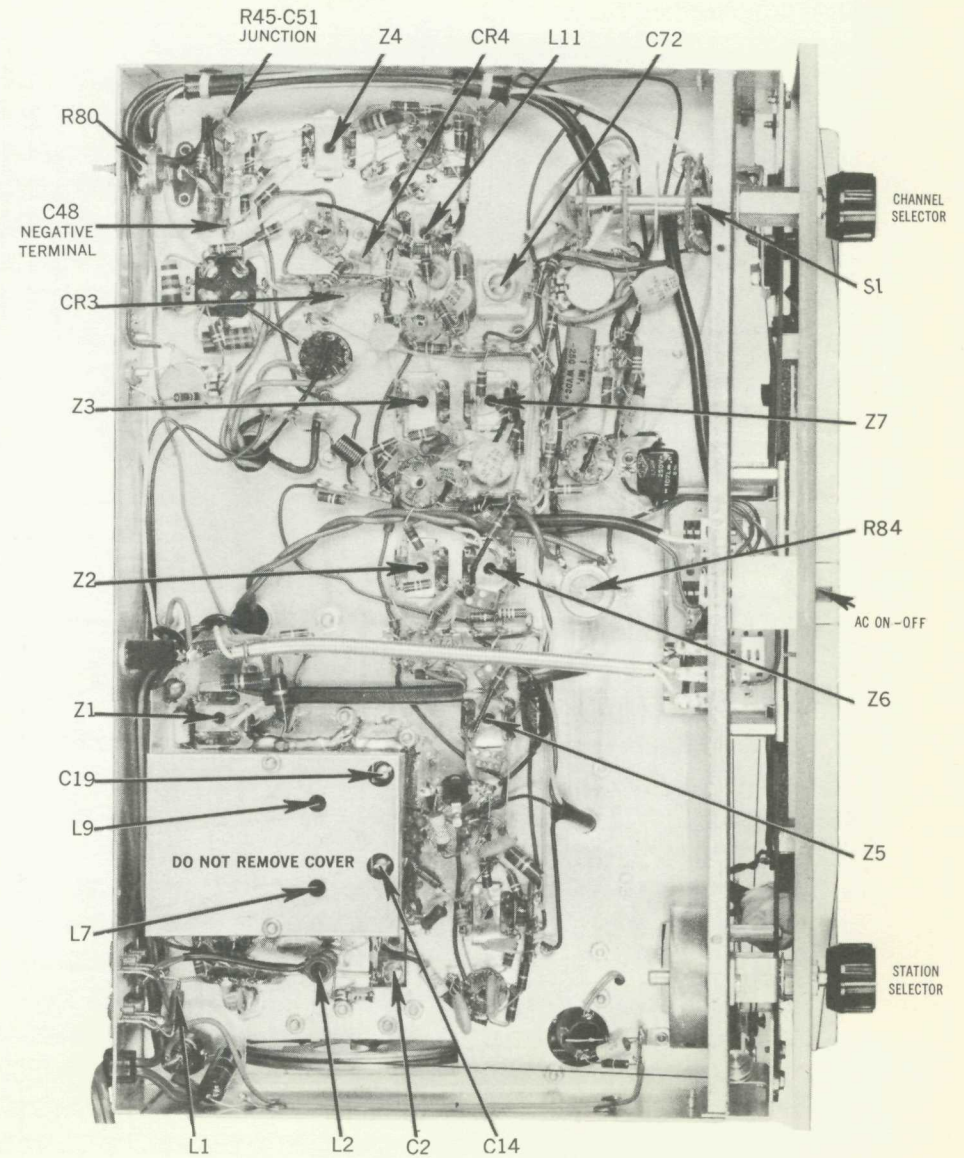

ALIGNMENT INSTRUCTIONS

Read These Instructions With Extreme Care Before Attempting Alignment.

CHASSIS: Turn the Station Selector completely counterclockwise, without forcing. Dial pointer should be at zero index mark on logging scale. If not, re-set the dial pointer as described under Dial Cord Replacement. Disconnect external antennas, antenna link between terminals 1 and 2. Set tone controls to flat. Turn loudness contour control and presence switch off. Switch rumble filter to 20 cycles, and noise filter to 20 KC. When using an oscilloscope for alignment, set volume control for no overload, as shown by proper waveform shape.

SIG. GEN: The signal generator equipment must be able to supply the following: AM RF modulated 30% at 400 cps, FM RF modulated 30% (± 22.5 -KC deviation) at 400 cps, accurately calibrated

10-KC audio output for adjusting 10-KC AM whistle filter, AM IF with 30-KC sweep for AM bandwidth adjustment.

INDICATOR: DC VTVM and SCOPE for alignment. AC VTVM for 10-KC AM whistle filter adjustment. AC VTVM and SCOPE for FM muting adjustment.

ALIGNMENT: Allow the chassis and test instruments to warm up for at least fifteen minutes. Adjust the line voltage for 117 volts AC, 50-60 cycles). Use fully insulated tools: a small slot-head screwdriver for all capacitors, L13 and L16; a K-tran tool for Z1, Z2, Z3, Z5, Z6, Z7, and L14; a hex tool for Z4, L2, L7 and L11.

AM ALIGNMENT

Switch channel selector to AM.

STEPS	CHASSIS			SIGNAL GENERATOR			INDICATOR		ALIGNMENT	
	PUSH BUTTONS	LOOP SW	STATION SELECTOR	COUPLING	FREQ.	MOD.	TYPE	CONNECTION	ADJUST	INDICATION
1	AM SHARP (DISTANT)	EXT	Point of no signal and no interference	.01-uf capacitor in series with hot lead to V8, pin 7	455 KC	30% AM at 400 cps	DC VTVM	to Z7 pin 2, or SCOPE to main output	Z5, Z6, Z7 top and bottom	Maximum negative voltage
2	"	"	1400 KC	220-uuf capacitor in series with hot lead to antenna terminal 2	1400 KC	"	"	"	C54, C61, C65	"
3	"	"	600 KC	"	600 KC	"	"	"	L13, L14 L16	"
4	Repeat steps 2 and 3 at least once for proper dial calibration									
5	AM SHARP (DISTANT)	LOOP	1400 KC	Hot lead loosely coupled to loopstick	1400 KC	"	"	"	C80	"
6	AM BROAD (LOCAL)	EXT	Point of no signal and no interference	.01-uf capacitor in series with hot lead to V8, pin 7	455 KC	30-KC sweep	SCOPE	Main output	Z7 top	Adjust slightly for symmetrical curve
7	OFF (DISTANT)	-	"	Ungrounded tube shield of V2	10.7 MC	None	DC VTVM	L11, pin 3	Z1, Z2, Z3 top and bottom, L11 bottom	Maximum negative voltage
8	"	-	"	"	"	"	"	C48, neg. terminal	Z4 bottom	"
9	"	-	"	"	"	"	"	R45-C51 junction	Z4 top	Zero reading on zero-center scale
10	"	-	106 MC	Two 120-ohm carbon resistors in series with leads to antenna terminals 5 and 6	106 MC	30% FM (22.5 KC dev) at 400 cps	DC VTVM to L11, pin 3, and SCOPE to main output		C 19	Check for sine waveform, and adjust for max negative voltage
11	"	-	90 MC	"	90 MC	"	"	"	L9	"
12	"	-	106 MC	"	106 MC	"	"	"	C2 & C14	"
13	"	-	90 MC	"	90 MC	"	"	"	L2 & L7	"
14	Repeat steps 4 through 7 at least once for proper dial calibration and maximum output									

FM ALIGNMENT

Switch channel selector to FM.

ADJUSTING FM MUTING LEVEL: Connect signal generator as in step 10 of Alignment Instructions. Tune chassis to 98 MC. Set signal generator for 98 MC with 30% FM (22.5 KC deviation) at 400 cps, and 100 uv output. Connect oscilloscope to main output, and check waveform for no overload and no clipping. Connect AC VTVM to main output and observe reading with DISTANT pushbutton depressed. Depress LOCAL pushbutton, and adjust R47 for reading 2 db below reading with DISTANT pushbutton depressed.

ADJUSTING 10-KC AM WHISTLE FILTER: Connect an audio oscillator to the junction of R24 and R25, and set for 10 KC. The oscillator MUST be accurately calibrated, or this adjustment should not be attempted. Connect an AC VTVM to the chassis main output. Make back-and-forth adjustments of R68 and C72 until a minimum reading is obtained on the meter. Use a small slot-head screwdriver for both adjustments.

DIAL CORD REPLACEMENT INSTRUCTIONS

1. Remove chassis from cabinet. Remove all knobs. Carefully remove the hexagonal nuts located behind the channel selector and station selector knobs. Remove the two hexagonal screws holding the brass panel assembly. These are located behind the front panel, near the upper corners. Carefully lift the brass panel away. Remove bottom cover.
2. Remove the defective cord and the dial pointer. String the new dial cord as shown in the diagram at the right. The three turns around the station selector shaft (behind the bracket) are made back-to-front in a clockwise direction.
3. Turn the station selector to its extreme counterclockwise position, without forcing. Slip the dial pointer onto the top edge of the metal front panel and position at the index mark at the low end of the logging scale. Thread the dial cord in the three clips at the back of the dial pointer, after affixing a small piece of tape to the cord at the point it passes under the center clip. Check the position of the dial pointer as at the beginning of this step, then apply household cement to secure the pointer to the dial cord.
4. Replace bottom cover. Replace the brass panel assembly, making sure to use both the hexagonal screws and the nuts removed in step 1.

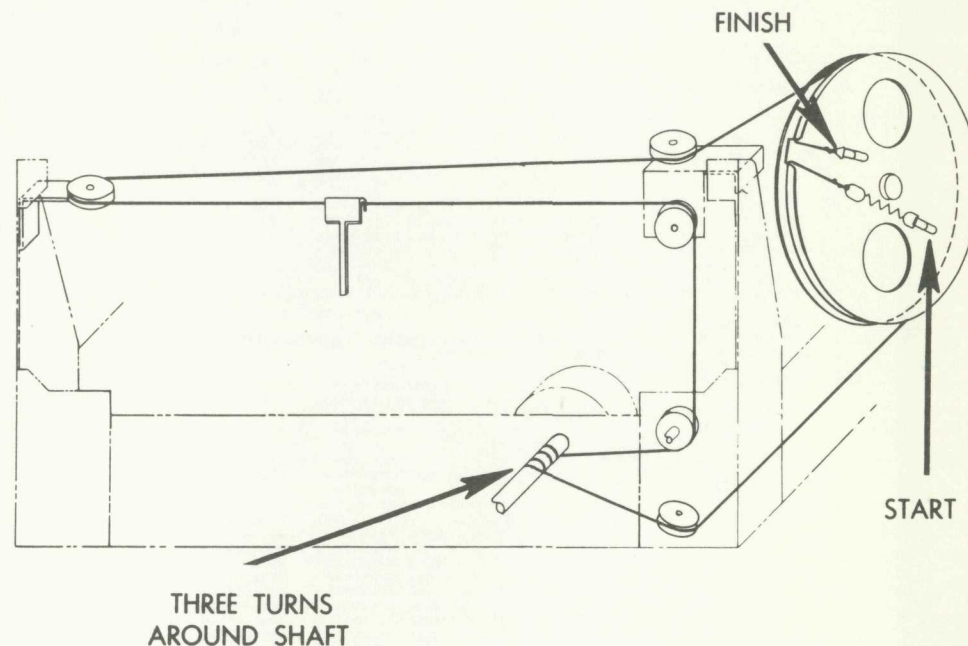

FISHER RADIO CORPORATION • LONG ISLAND CITY 1 • NEW YORK